



Management of Long-Chain Fatty Acid Oxidation Disorder: Pharmacist, Provider, and Patient Perspectives



This educational activity is sponsored by Postgraduate Healthcare Education, LLC and supported by an educational grant from Ultragenyx Pharmaceutical, Inc.

Moderator/Faculty

Richard J. Faris, PhD, MSc, RPh

Senior Vice President, Head of Pharmacy
PANTHERx Rare, LLC

Dr. Faris is Senior Vice President and Head of Pharmacy for PANTHERx Rare Pharmacy. In this role, he is responsible for RxARECARE pharmacy operations, clinical and patient engagement services, program management, and implementation. PANTHERx Rare Pharmacy focuses on serving people living with rare and devastating conditions. Prior to joining PANTHERx, Dr. Faris was Vice President for Clinical Strategy and Services with DaVita Rx. He has also served as Accredo Specialty Pharmacy's Vice President for Clinical Services and Health Outcomes Solutions, and Medco's/ESI's National Practice Leader for Rare and Specialty Therapeutic Resource Centers. He has held leadership positions in health systems, industry, and academia, including being the founding Director for the Center for Pharmaceutical Outcomes and Policy with The Johns Hopkins Hospital. Dr. Faris received his Pharmacy degree from the University of Mississippi and completed a combined Masters degree/residency program with the University of Minnesota and United and Children's Hospitals of St. Paul. He went on to complete his PhD at the University of Florida. He has served on committees for several national organizations and was recently a Board Member for the Pharmacy Quality Alliance, where he also chaired specialty pharmacy measure development efforts for several years.



Faculty

Nicola Longo, MD, PhD

Professor of Pediatrics and Chief
Division of Medical Genetics, Department of Pediatrics
Medical Genetics/Pediatrics
University of Utah
Salt Lake City, UT

Dr. Longo is Professor of Pediatrics and Chief in the Division of Medical Genetics, Department of Pediatrics at the University of Utah in Salt Lake City. He received his MD and PhD in molecular biology and pathology from the University of Parma School of Medicine in Italy. He then trained in Pediatrics, Medical and Biochemical Genetics at Emory University in Atlanta, Georgia.

Dr. Longo is board certified in medical genetics and clinical biochemical genetics. His research concerns the molecular bases of metabolic disorders, their natural history, their identification through newborn screening, and the development of novel therapies.



Faculty

Tasia Rechisky

Tasia Rechisky is a Boston University graduate and long-time rare disease advocate.

At six months of age, Tasia was diagnosed with Very-Long-Chain Acyl-CoA Dehydrogenase Deficiency (VLCADD), a rare metabolic disorder. She is an active member of the broader rare disease community, speaking at several universities and forums to physicians, genetic counselors, medical students, and researchers on the impact of living with a rare disease and, specifically, a fatty acid oxidation disorder. She is a committee member of Rare New England and a member of the Fatty Acid Oxidation Disorder patient leadership council for Ultragenyx Pharmaceutical.



Disclosures

Dr. Faris has disclosed that he is an employee of PANTHERx Rare Pharmacy.

Dr. Longo has disclosed that he has served as a consultant and clinical investigator for Reneo Pharmaceuticals and Ultragenyx Pharmaceutical, Inc.

Ms. Rechisky has disclosed that she has served as a consultant for the Ultragenyx Patient Leadership Council.

The clinical reviewer, **Daphne Davis, PharmD, BCOP** has no actual or potential conflicts of interest in relation to this program.

Susanne Batesko, RN, BSN, Kim Minitier, MSEd, and Susan R. Grady, MSN, RN-BC, as well as the planners, managers, and other individuals, not previously disclosed, who are in a position to control the content of Postgraduate Healthcare Education (PHE) continuing education activities hereby state that they have no relevant conflicts of interest and no financial relationships or relationships to products or devices during the past 12 months to disclose in relation to this activity. PHE is committed to providing participants with a quality learning experience and to improve clinical outcomes without promoting the financial interests of a proprietary business.



Postgraduate Healthcare Education, LLC is accredited by the Accreditation Council for Pharmacy Education as a provider of continuing pharmacy education.

UAN: 0430-0000-20-013-H01-P

Credits: 1.5 hour (0.15 CEU)

Type of Activity: Application





Dr. Richard Faris

Learning Objectives

- 
- **Identify** the signs and symptoms of long-chain fatty acid oxidation disorder (LCFAOD)
 - **Design** an appropriate diet for a patient with LCFAOD
 - **Describe** current treatments for LCFAOD
 - **Explain** the potential role of triheptanoin and other emerging treatments for LCFAOD
 - **Describe** the role of specialty pharmacy in rare diseases



Dr. Nicola Longo

Learning Objectives

- **Define** the role of fatty acid oxidation in fasting
- **Recognize** the role of carnitine in fatty acid oxidation
- **Define** principles of treatment of fatty acid oxidation defects





- Fatty acid oxidation plays a major role in energy production during fasting
 - It requires at least 20 individual steps, some of which are catalyzed by enzymes with overlapping chain-length specificities
- Carnitine carries fatty acids inside mitochondria
 - The beta oxidation cycle can extract energy from them
- All known fatty acid oxidation defects are transmitted as autosomal recessive traits

Fatty Acid Oxidation

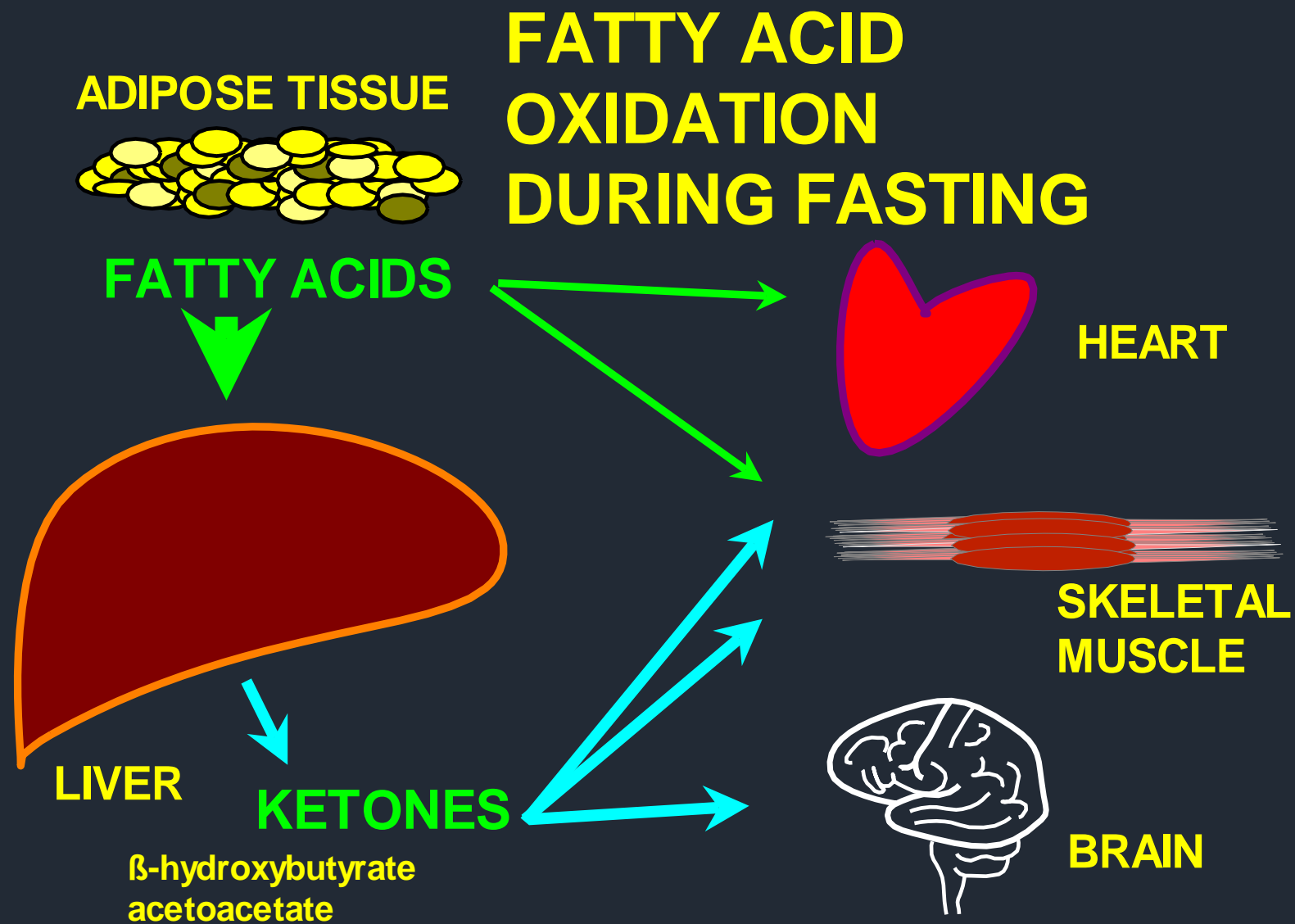

Fatty Acid Oxidation

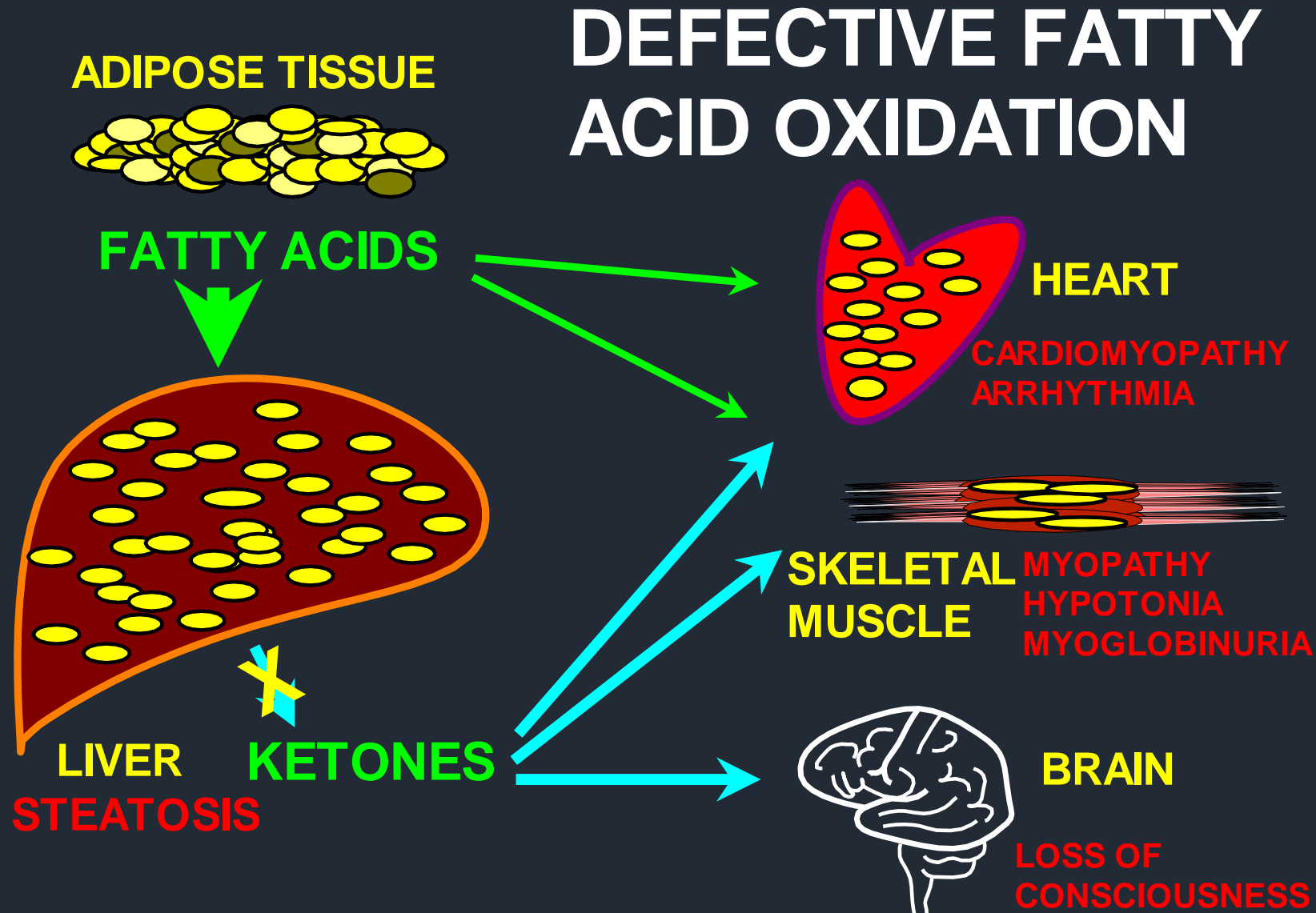

Triggers of Fatty Acid Oxidation Defects

- Most fatty acid oxidation defects are episodic and clinically silent when fat is not utilized
- Triggering conditions include fever, infections, gastroenteritis, and reduced caloric intake
- Children often present shortly after birth (initiation of breastfeeding) or at any age during an illness causing catabolism



Fatty Acid Oxidation Disorders

- Fatty acid oxidation disorders (FAODs) are relatively frequent
- Cause: More than 20 enzymes/transporters are involved in fatty acid oxidation
 - They are all autosomal recessive
- Epidemiology: Most frequent is MCAD deficiency (1:10,000)
 - All others are much rarer (1:30,000-1:1,000,000)
- Pathogenesis: Accumulation of fat and toxic metabolites, lack of energy, cell death
 - On autopsy, fat infiltration of all tissues is observed

Fatty Acid Oxidation Disorders

- **Presentation:** Fasting-induced hypoketotic hypoglycemia, liver failure, hyperammonemia (Reye syndrome), cardiomyopathy, myopathy, hypotonia, neuropathy, arrhythmia, sudden death, rhabdomyolysis
- **Diagnosis:** Plasma carnitine and acylcarnitine profile, urine organic acids during acute attack, free fatty acids, DNA studies, in vitro probes, fibroblast enzyme/transport assay
- **Therapy:** Fasting avoidance, prompt treatment of infections, low-fat diet, MCT oil/triheptanoin (in some), carnitine, essential fatty acids, ketones

Carnitine in Fatty Acid Oxidation

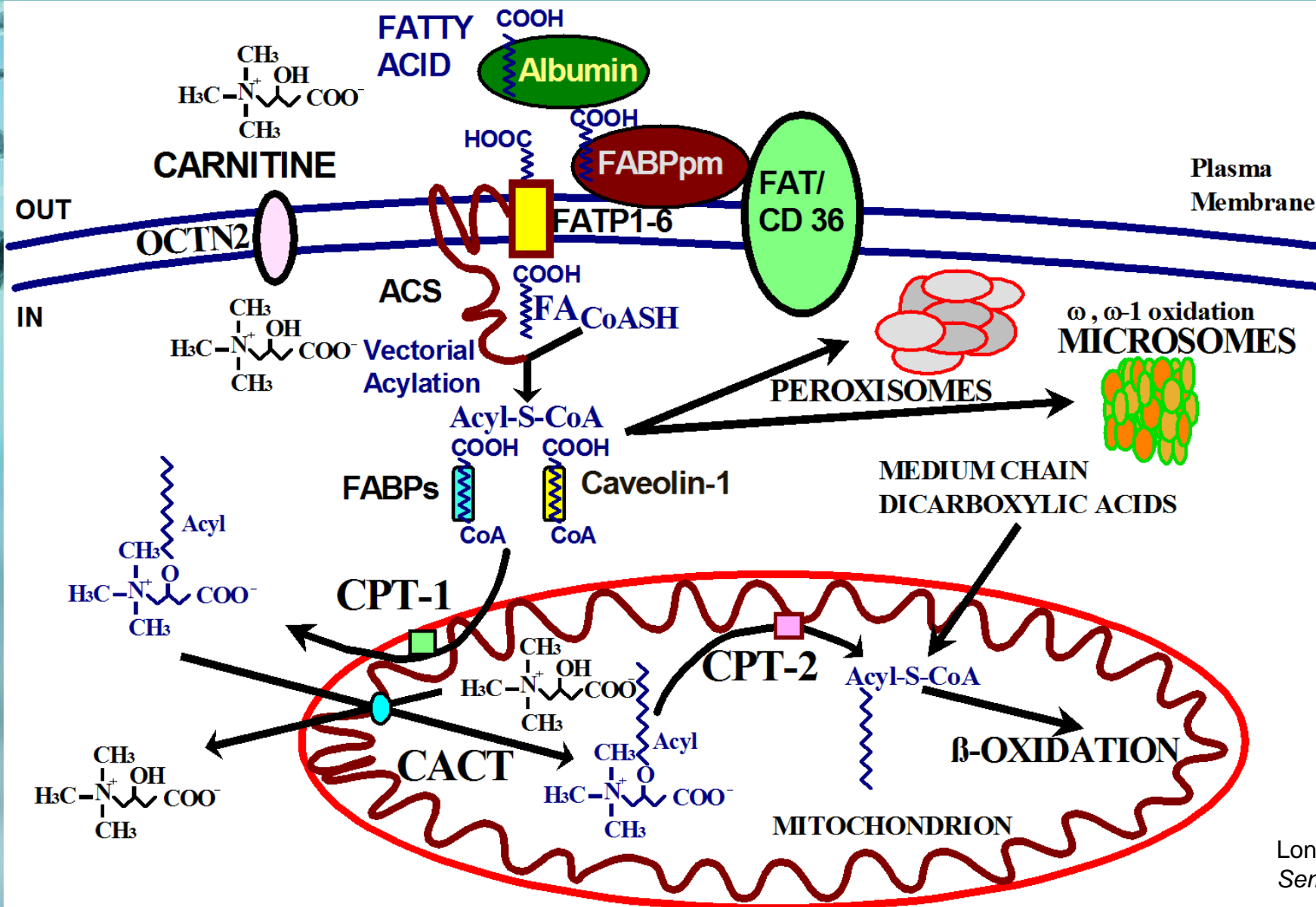

Fatty acids are conjugated with carnitine to enter the mitochondrial matrix

Mitochondrial Fatty Acid Oxidation

β-OXIDATION

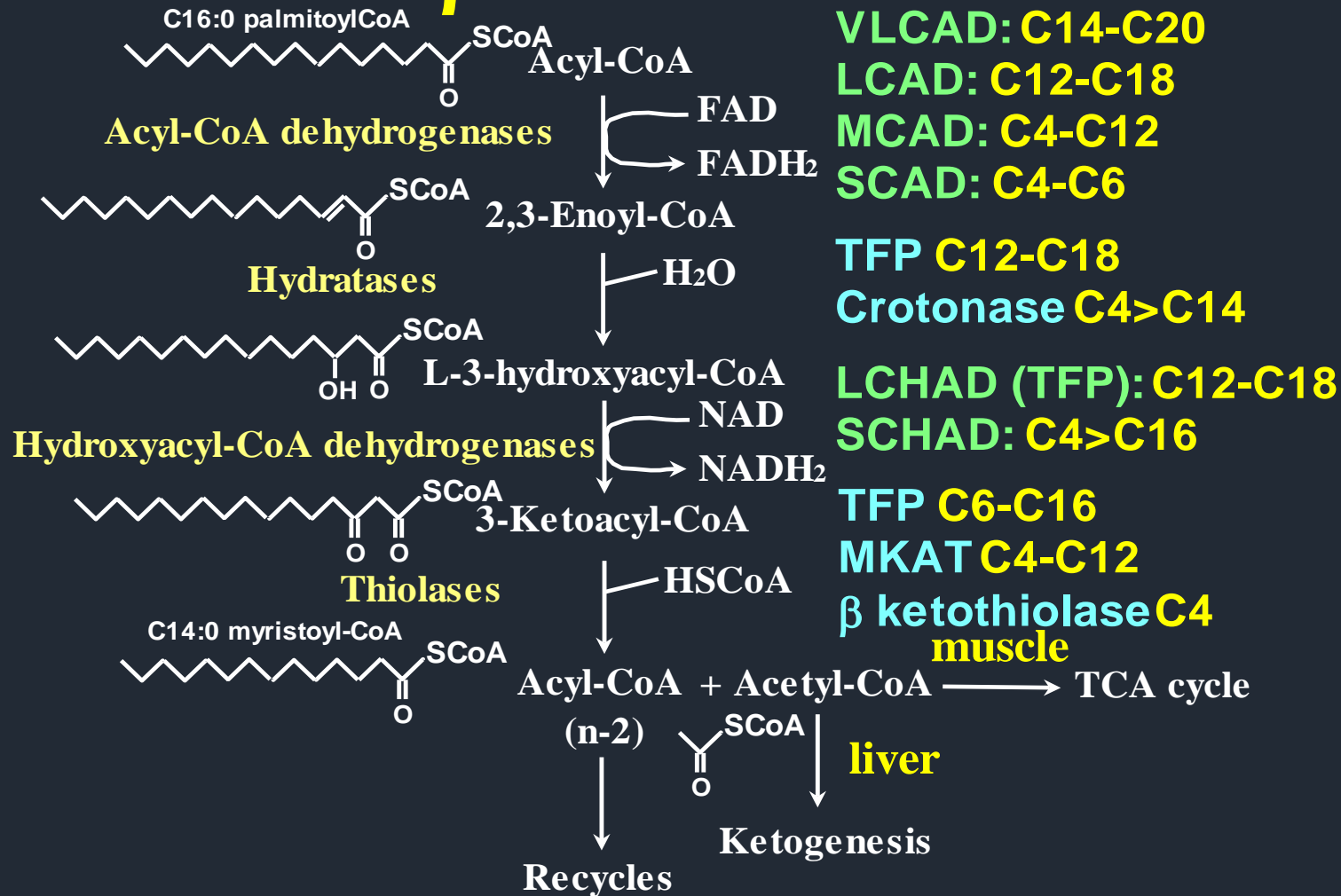

Beta oxidation shortens long-chain fatty acids by 2 carbons at a time, generating energy through the Krebs cycle or ketones in the liver

Fatty Acid Oxidation Disorders

- Pathogenesis: Accumulation of fat and toxic metabolites
 - Lack of energy
- Long-chain fatty acids and, to a lesser extent, long-chain acylcarnitines, can have toxic effects and cause cardiac arrhythmia
- Lack of energy can lead to organ failure and cell death
 - Hypoglycemia can be present but is usually a late sign of FAODs

Emergency Protocol for Patients with FAOD

- If unable to eat, give IV fluids to provide calories:
 - D10 (10% glucose); 75-150 mEq/L NaCl; 20 mEq/L KCl at 150 mL/kg per day
- Labs/imaging to identify cause of problems, mostly infections (cultures/X-rays)
 - Electrolytes, liver function tests, creatinine kinase, plasma ammonia, urine analysis
- Start enteral feeds as soon as tolerated

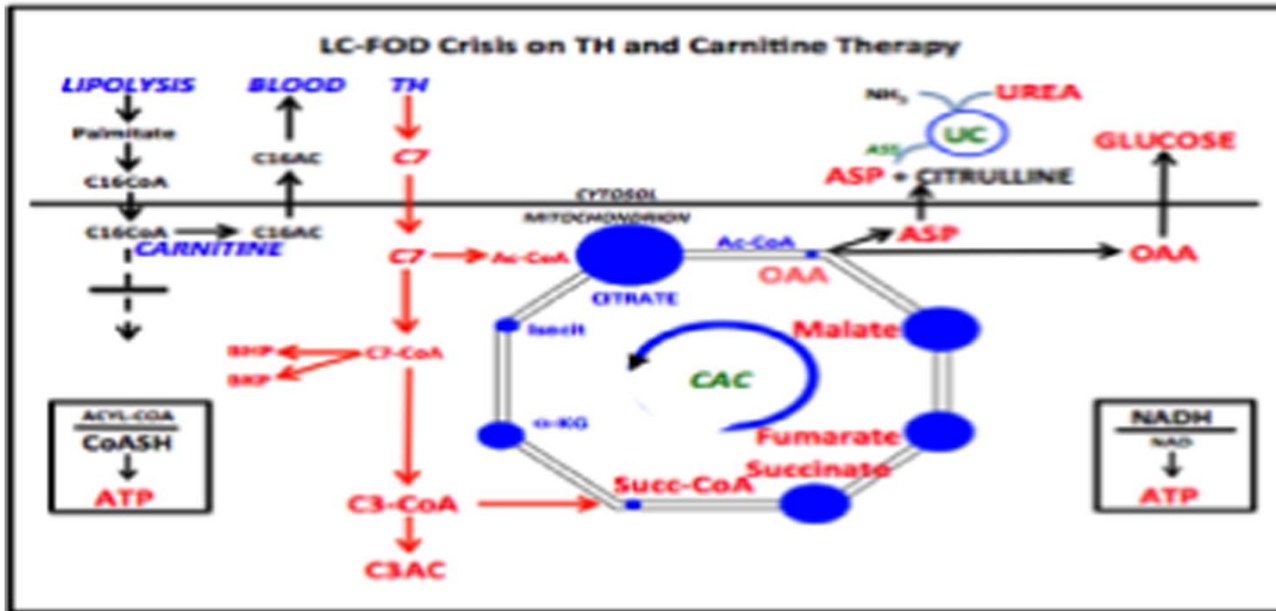
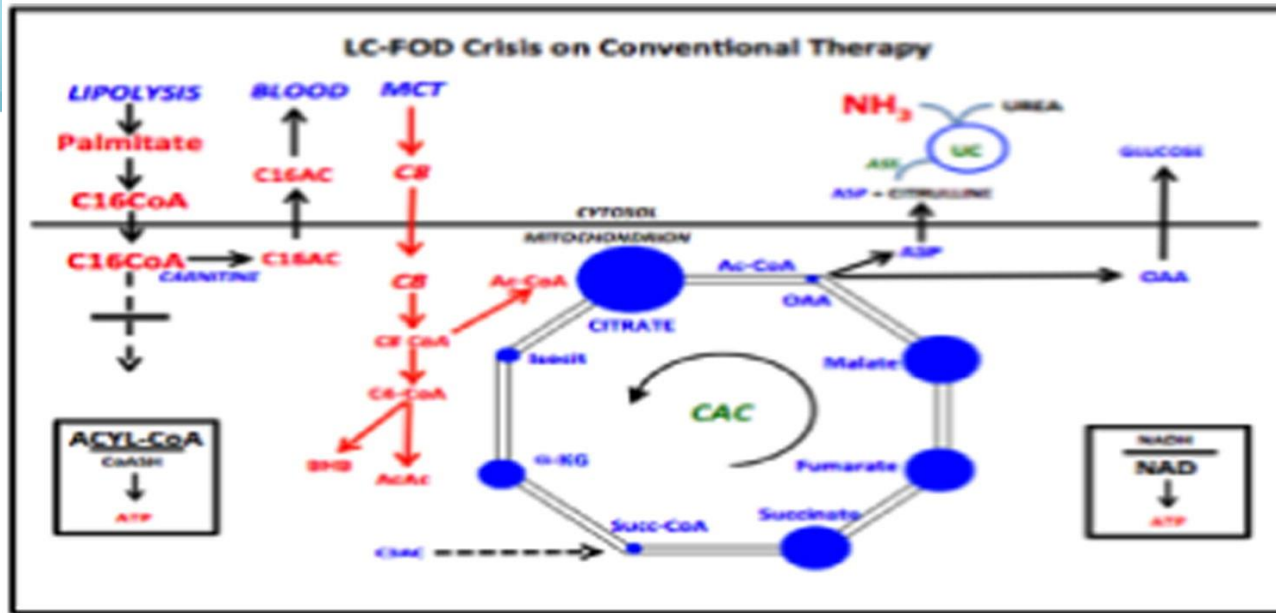

Medium-Chain Fats in the Therapy of LCFAODs

- Clinical complications caused by energy deficiency resulting from insufficient availability of intermediates of the citric acid cycle that compromises ATP production
- With even-chain fatty acids (MCT oil), substrate is provided (acetyl-CoA), but intermediates of the Krebs cycle might run out
- Triheptanoin replenishes succinyl-CoA (anaplerosis) while also providing acetyl-CoA

Neonatal Cardiac Arrest

- Term infant developed hypothermia, desaturations, low blood pressure, and hypoglycemia (glucose 7 mg/dL) at 18 h of age
 - Intubated, developed tachy- and bradycardia
 - Cardiac ECHO: cardiomyopathy
- Had cardiac arrest requiring 5 min of chest compressions
- Had mild hyperammonemia with increased liver function tests (ALT/AST up to 400) and mildly increased CPK (up to 350)
- Started on IV glucose with stabilization

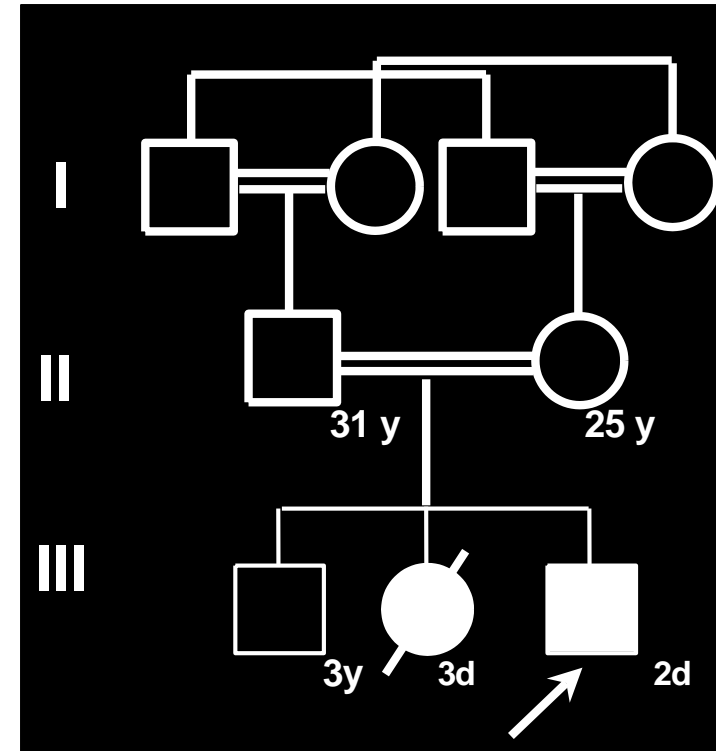

ALT, alanine transaminase;
AST, aspartate transaminase;
CPK, creatine phosphokinase;
ECHO, echocardiogram.

Diagnosis: Plasma Acylcarnitine Profile

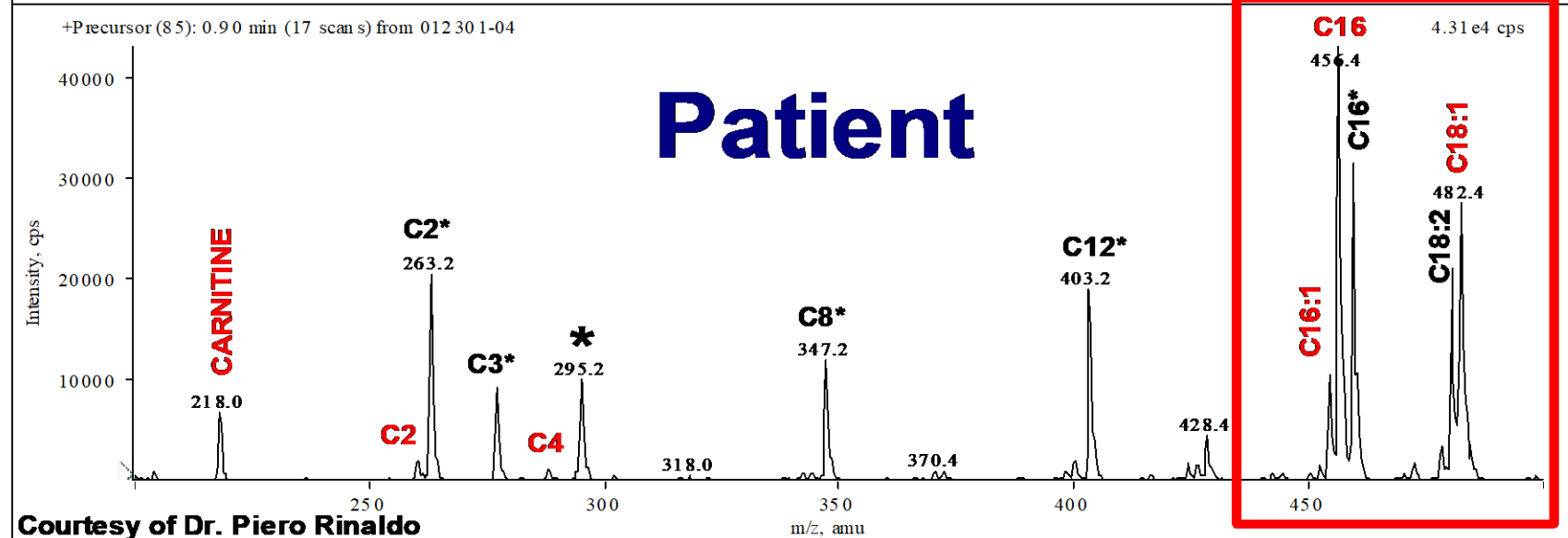
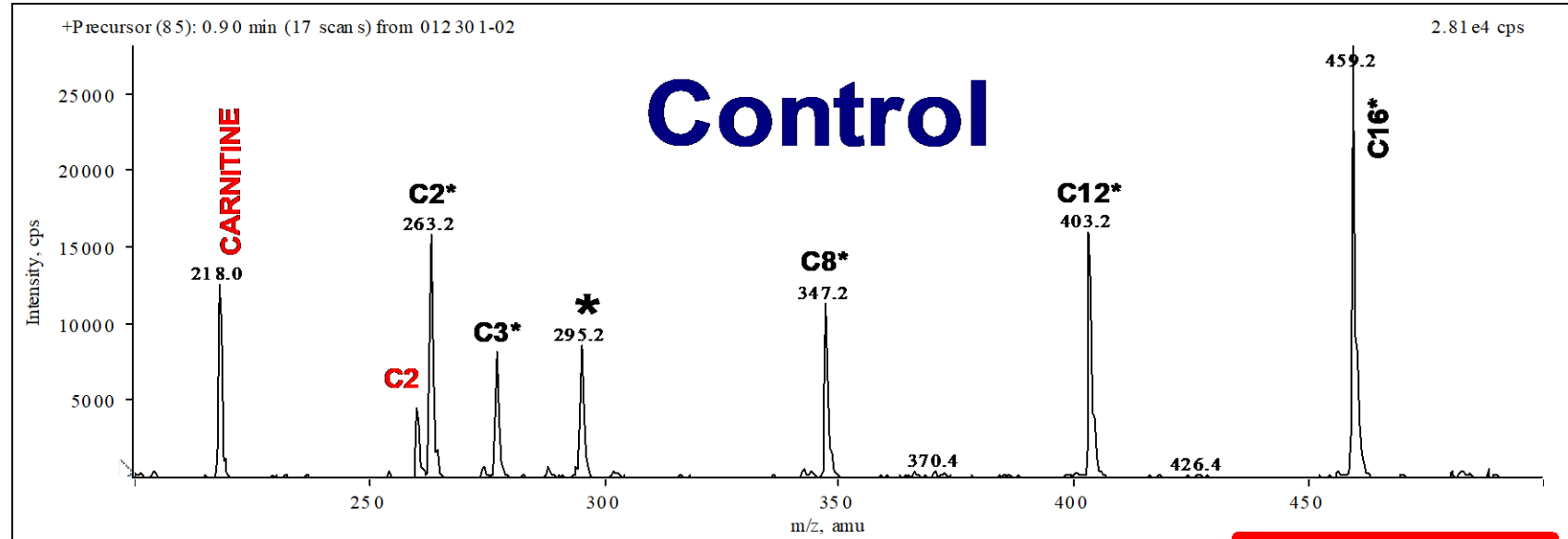

Carnitine Acylcarnitine Translocase (CACT) Deficiency MIM 212138

- 
- Frequency: Very rare
 - Cause/Pathogenesis: Deficiency of the acylcarnitine translocator impairs entry of long-chain acylcarnitines into mitochondria
 - Results in the accumulation of long-chain acylcarnitine, long-chain fatty acids, and defective energy production
 - Presentation: Arrhythmia, cardiac arrest shortly after birth, hypoketotic hypoglycemia, cardiomyopathy
 - Diagnosis: Abnormal acylcarnitine profile (low C0, increased C16-C18:1), abnormal organic acids (dicarboxylic aciduria)
 - Confirmed by DNA testing
 - Identified by newborn screening
 - Most infants present before newborn screening is obtained

Carnitine Acylcarnitine Translocase (CACT) Deficiency MIM 212138

- Therapy: Fasting avoidance, low-fat diet, MCT oil, carnitine
- Monitoring: Acylcarnitine profile, carnitine F & T, CK, ALT, AST
- Prognosis: Not always good, but there are teenagers with milder variants doing well with therapy

CK, creatine kinase.

Iacobazzi V, et al. *Am J Med Genet A*. 2004;126A(2):150-5.

The Carnitine Cycle in Fatty Acid Oxidation

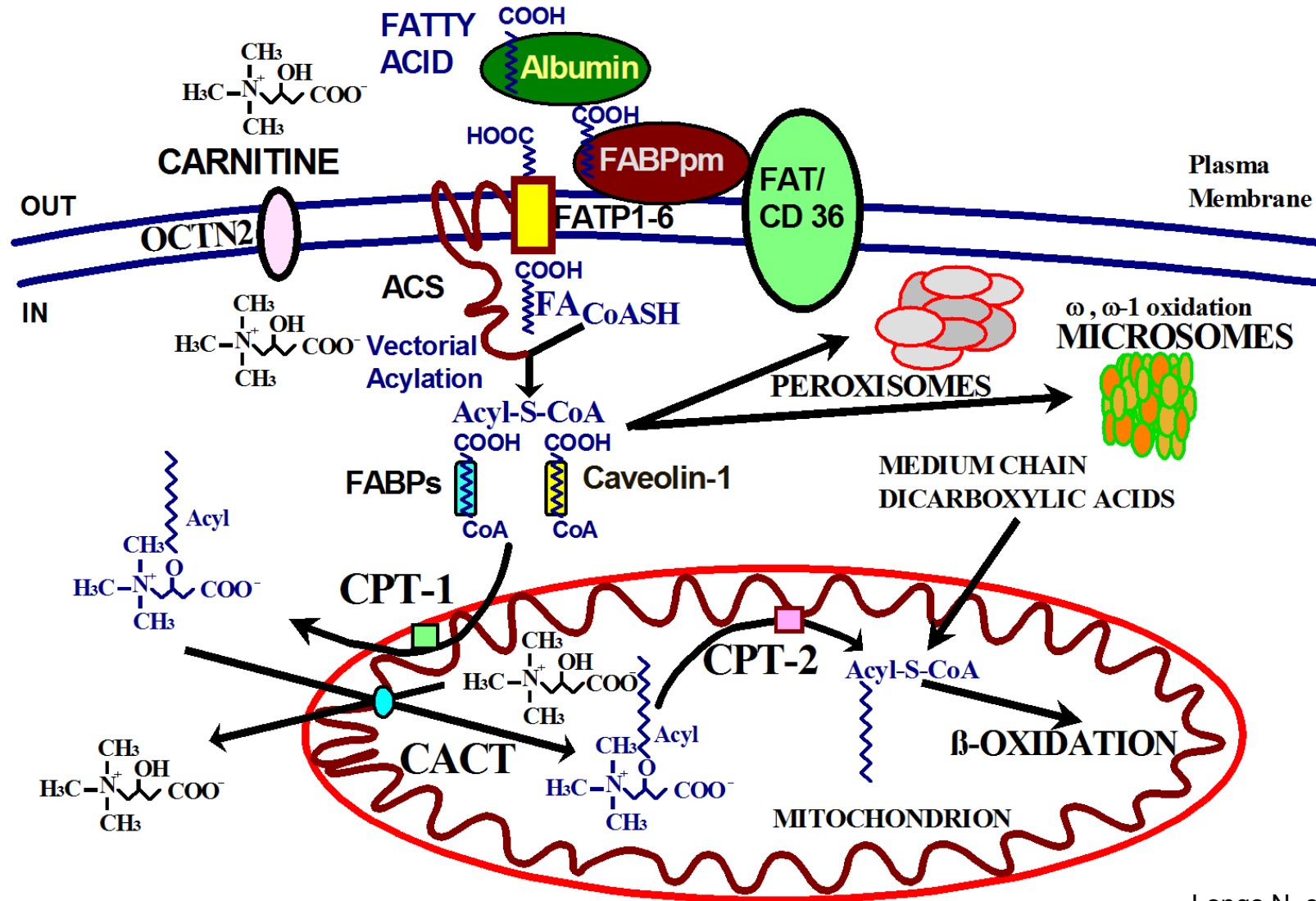

Progressive Normalization of Carnitine Levels in a Patient with CACT Deficiency with Carnitine and Medium-Chain Triglycerides

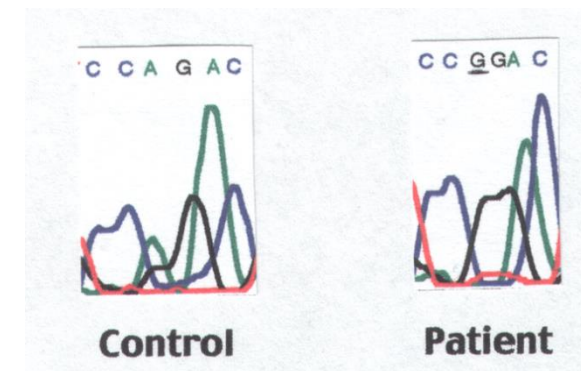
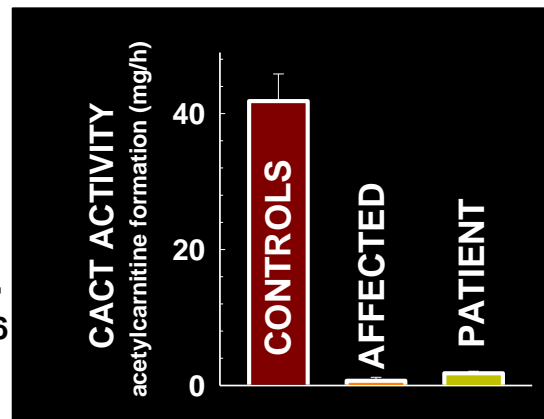
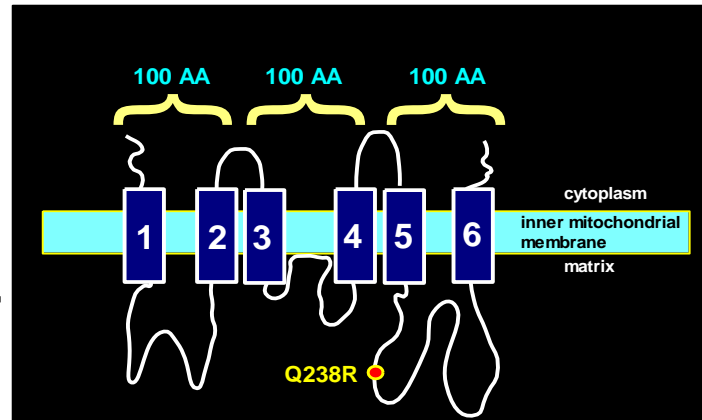
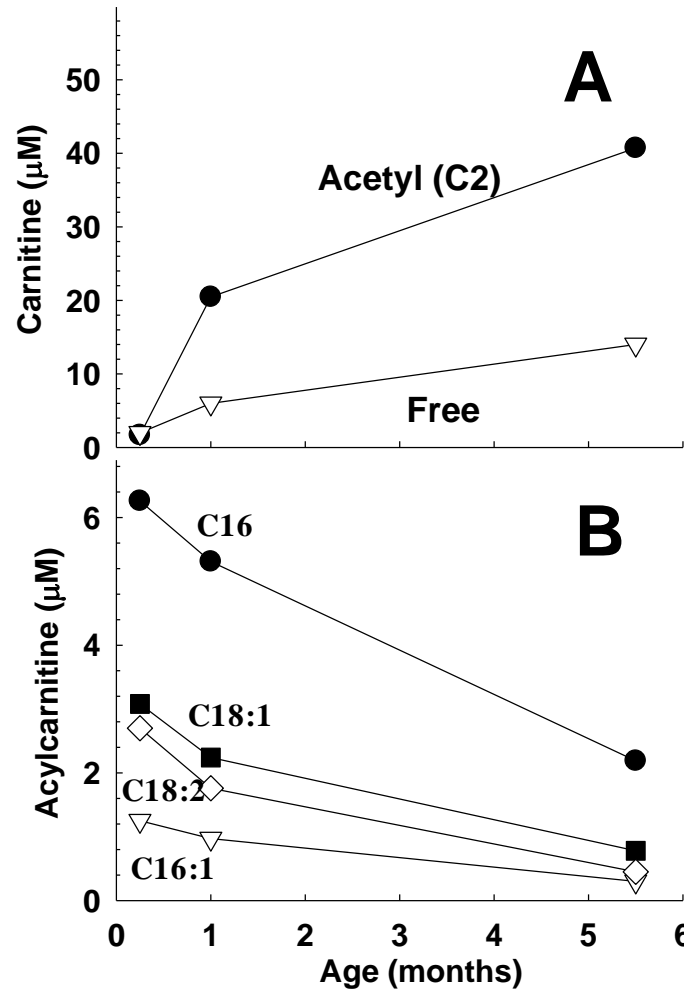

Carnitine Palmitoyl Transferase-2 (CPT-2) Deficiency

- 78-year-old man hospitalized for persistent muscle cramps and myoglobinuria
- Has not been able to run or participate in sustained physical exercise since he was a teenager
- Was in the military during 2 wars but was assigned to an office
- Now, he develops muscle pain and myoglobinuria even without exercise (P50H/unk)

	Last Ref. Range	08.06.07 10:30	12/18.06 12.25	11.09.06 12.00
C2, Acetyl		13.53	^ 10.23	^ 7.21
C3, Propionyl		0.53	^ 0.77	^ 0.68
C4, Iso/Butyryl		0.27	^ 0.24	^ 0.27
C5, Isovaleryl/2Methylbutyryl		0.16	^ 0.15	^ 0.10
C5-DC, Glutaryl		0.04	^ 0.03	^ 0.08
C6, Hexanoyl		0.09	^ 0.10	^ 0.12
C8, Octanoyl		0.10	^ 0.16	^ 0.13
C8:1, Octenoyl		0.24	^ 0.36	^ 0.14
C10, Decanoyl		0.24	^ 0.28	^ 0.15
C10:1, Decenoyl		0.16	^ 0.21	^ 0.22
C12, Dodecanoyl		0.17 H	^ 0.18 H	^ 0.10
C12:1, Dodecenoyl		0.07	^ 0.11	^ 0.19 H
C12-OH, 3-OH Dodecanoyl		0.03 H	^ 0.06 H	^ 0.01
C14, Tetradecanoyl		0.14 H	^ 0.10 H	^ 0.11 H
C14:1, Tetradecenoyl		0.08	^ 0.06	^ 0.09
C14:2, Tetradecadienoyl		0.03	^ 0.05	^ 0.04
C14-OH, 3-OH-Tetradecanoyl		0.02	^ 0.02	^ 0.00
C14:1-OH, 3-OH-Tetradecenoyl		0.03 H	^ 0.05 H	^ 0.05 H
C16, Palmitoyl		0.76 H	^ 0.46 H	^ 0.70 H
C16:1, Palmitoleyl		0.05 H	^ 0.06 H	^ 0.08 H
C16-OH, 3-OH-Palmitoyl		0.01	^ 0.01	^ 0.03 H
C16:1-OH, 3-OH-Palmitoleyl		0.03 H	^ 0.03 H	^ 0.03 H
C18, Stearoyl		0.37 H	^ 0.31 H	^ 0.36 H
C18:1, Oleyl		0.49 H	^ 0.41 H	^ 0.82 H
C18:2, Linoleyl		0.25 H	^ 0.21 H	^ 0.20 H
C18-OH, 3-OH-Stearoyl		0.01	^ 0.01	^ 0.04 H
C18:1-OH, 3-OH-Oleyl		0.02 H	^ 0.01	^ 0.03 H
C18:2-OH, 3-OH-Linoleyl		0.02 H	^ 0.01	^ 0.02 H

CPT-2 Deficiency

- Frequency: Very rare
 - Myopathic form is still rare, but with several reported cases (> 300)
- Cause/Pathogenesis: Deficiency of CPT-2 impairs the transfer of long-chain fatty acids from carnitine to CoA synthesis of long-chain acylcarnitine
 - Results in the accumulation of long-chain acylcarnitine, long-chain fatty acids, and defective energy production
- Presentation:
 1. Lethal neonatal 608836: respiratory failure, liver failure, cardiomyopathy, arrhythmia, hypoglycemia
 2. Severe infantile 600649: hypoglycemia, seizures, hepatomegaly, cardiomyopathy, arrhythmia
 3. Myopathic 255110: muscle pain with exercise

CPT-2 Deficiency

- Diagnosis: Abnormal acylcarnitine profile (increased C16-C18)
 - Confirmed by DNA testing
 - Identified by newborn screening, but infants can be easily missed (profile can be normal at birth)
- Therapy: Fasting avoidance, MCT oil, sugary drinks with exercise
- Monitoring: ALT, AST, CK, acylcarnitines
- Prognosis: Myopathic form is compatible with long life

Very Long Chain Acyl-CoA Dehydrogenase (VLCAD) Deficiency MIM 201450

- 8-year-old hospitalized after being unable to move or wake up completely
 - Woke up moaning, crying, unable to focus, drink, or walk
- Admitted to Intensive Care for 6 days and found to have cardiomyopathy with low cardiac ejection fraction, elevated CK, and cardiomegaly on chest X-ray

	11/12/07 17:25	05/2 1.07 12:16	12/18/06 12:00	10/23/06 13:15	08/30/06 15:20
C2, Acetyl	^ 6.42	^ 16.34	^ 16.14	^ 4.68	^ 8.34
C3, Propionyl	^ 0.44	^ 0.51	^ 0.52	^ 0.37	^ 1.33 H
C4, Iso/Butyryl	^ 0.25	^ 0.26	^ 0.28	^ 0.29	^ 0.42
C5, Isovaleryl/2Mebutyryl	^ 0.10	^ 0.08	^ 0.04	^ 0.05	^ 0.13
C5-DC, Glutaryl	^ 0.02	^ 0.03	^ 0.03	^ 0.10 H	^ 0.04
C6, Hexanoyl	^ 0.18 H	^ 0.24 H	^ 0.30 H	^ 0.18 H	^ 0.25 H
C8, Octanoyl	^ 0.14	^ 0.17	^ 0.16	^ 0.10	^ 0.06
C8:1, Octenoyl	^ 0.03	^ 0.05	^ 0.05	^ 0.09	^ 0.06
C10, Decanoyl	^ 0.11	^ 0.17	^ 0.18	^ 0.28	^ 0.17
C10:1, Decenoyl	^ 0.03	^ 0.04	^ 0.04	^ 0.48 H	^ 0.11
C12, Dodecanoyl	^ 0.09	^ 0.15 H	^ 0.21 H	^ 0.90 H	^ 0.48 H
C12:1, Dodecenoyl	^ 0.03	^ 0.04	^ 0.13	^ 0.49 H	^ 0.15
C12-OH, 3-OH Dodecanoyl	^ 0.00	^ 0.01	^ 0.02	^ 0.09 H	^ 0.01
C14, Tetradecanoyl	^ 0.37 H	^ 0.52 H	^ 0.77 H	^ 1.90 H	^ 0.77 H
C14:1, Tetradecenoyl	^ 0.47 H	^ 1.31 H	^ 1.93 H	^ 6.70 H	^ 2.78 H
C14:2, Tetradecadienoyl	^ 0.13 H	^ 0.25 H	^ 0.31 H	^ 0.96 H	^ 0.47 H
C14-OH, 3-OH-Tetradecanoyl	^ 0.01	^ 0.01	^ 0.02	^ 0.04 H	^ 0.02
C14:1-OH, 3-OH-Tetradecenoyl	^ 0.03 H	^ 0.03 H	^ 0.05 H	^ 0.22 H	^ 0.05 H
C16, Palmitoyl	^ 0.36 H	^ 0.46 H	^ 0.70 H	^ 3.33 H	^ 0.99 H
C16:1, Palmitoleyl	^ 0.10 H	^ 0.22 H	^ 0.39 H	^ 2.14 H	^ 0.50 H
C16-OH, 3-OH-Palmitoyl	^ 0.00	^ 0.02 H	^ 0.02 H	^ 0.03 H	^ 0.01
C16:1-OH, 3-OH-Palmitoleyl	^ 0.03 H	^ 0.01	^ 0.03 H	^ 0.17 H	^ 0.05 H
C18, Stearoyl	^ 0.13 H	^ 0.16 H	^ 0.24 H	^ 1.40 H	^ 0.68 H
C18:1, Oleyl	^ 0.14	^ 0.25 H	^ 0.47 H	^ 3.33 H	^ 1.07 H
C18:2, Linoleyl	^ 0.05	^ 0.09	^ 0.18 H	^ 0.95 H	^ 0.29 H
C18-OH, 3-OH-Stearoyl	^ 0.01	^ 0.01	^ 0.01	^ 0.05 H	^ 0.02 H
C18:1-OH, 3-OH-Oleyl	^ 0.01	^ 0.01	^ 0.01	^ 0.11 H	^ 0.02 H
C18:2-OH, 3-OH-Linoleyl	^ 0.00	^ 0.02 H	^ 0.01	^ 0.11 H	^ 0.03 H

VLCAD Deficiency MIM 201450

- *Relatively common FAOD*
- Frequency: 1:63,481 (USA), 1:27,617 (Utah)
- Cause: Mutations in *ACADVL* gene
- Presentation:
 1. Early onset, hypertrophic cardiomyopathy, high morbidity and mortality
 2. Milder form with hypoketotic hypoglycemia, similar to MCAD deficiency with increased LFTs, elevated CPK
 3. Stress-induced rhabdomyolysis, like myopathic CPT2 deficiency

LFTs, liver function tests.

VLCAD Deficiency MIM 201450

- **Diagnosis:** Plasma acylcarnitine profile (elevated C14:1, normalizes rapidly after stress), DNA testing (part of initial tests), fatty acid oxidation fluxes, VLCAD enzyme assay
- **Therapy:** Fasting avoidance, prompt treatment of infection, MCT oil in patients with persistently abnormal acylcarnitines, low-fat diet, essential fatty acids, carnitine (25 mg/kg) with low plasma levels (unproven), MCT oil/triheptanoin, sugary drinks with exercise
- **Monitoring:** AST, ALT, CK, carnitine F & T, acylcarnitines, cardiac ECHO, ECG, Holter monitoring
- **Prognosis:** Can be good with treatment

ECG, electrocardiogram.

Long-Chain 3-OH-Acyl-CoA Dehydrogenase (LCHAD) 609016 / Trifunctional Protein (TFP) 609105 Deficiency

- LCHAD is part of a trifunctional protein (TFP)
 - Mutations can abolish all 3 functions or only LCHAD activity
- Frequency: 1:303,222 (USA), 1:255,365 (Utah)
- Cause: Mutations in *HADHA* or *HADHB* gene
- Presentation: IUGR, prematurity, fasting-induced vomiting and hypoglycemia, hypotonia, cardiomyopathy, liver dysfunction, sudden death
 - Rhabdomyolysis with stress/exercise/fasting
 - Retinitis pigmentosa with time
 - Neuropathy (more pronounced in TFP deficiency)
 - Preeclampsia in mothers of infants with LCHAD deficiency

IUGR, intrauterine growth restriction.

Long-Chain 3-OH-Acyl-CoA Dehydrogenase (LCHAD) 609016 / Trifunctional Protein (TFP) 609105 Deficiency

- Diagnosis: Plasma acylcarnitine profile, DNA testing
- Therapy: Fasting avoidance, MCT oil/triheptanoin, low-fat diet, essential fatty acids, carnitine (25 mg/kg) with low plasma levels (unproven)
- Monitoring: AST, ALT, CK, carnitine F & T, acylcarnitines, essential fatty acids, eye examination, cardiac ECHO, ECG, Holter monitoring
- Prognosis: Bad without treatment
 - Even with treatment, there are problems (muscle pain, retinitis pigmentosa, neuropathy)

β-OXIDATION

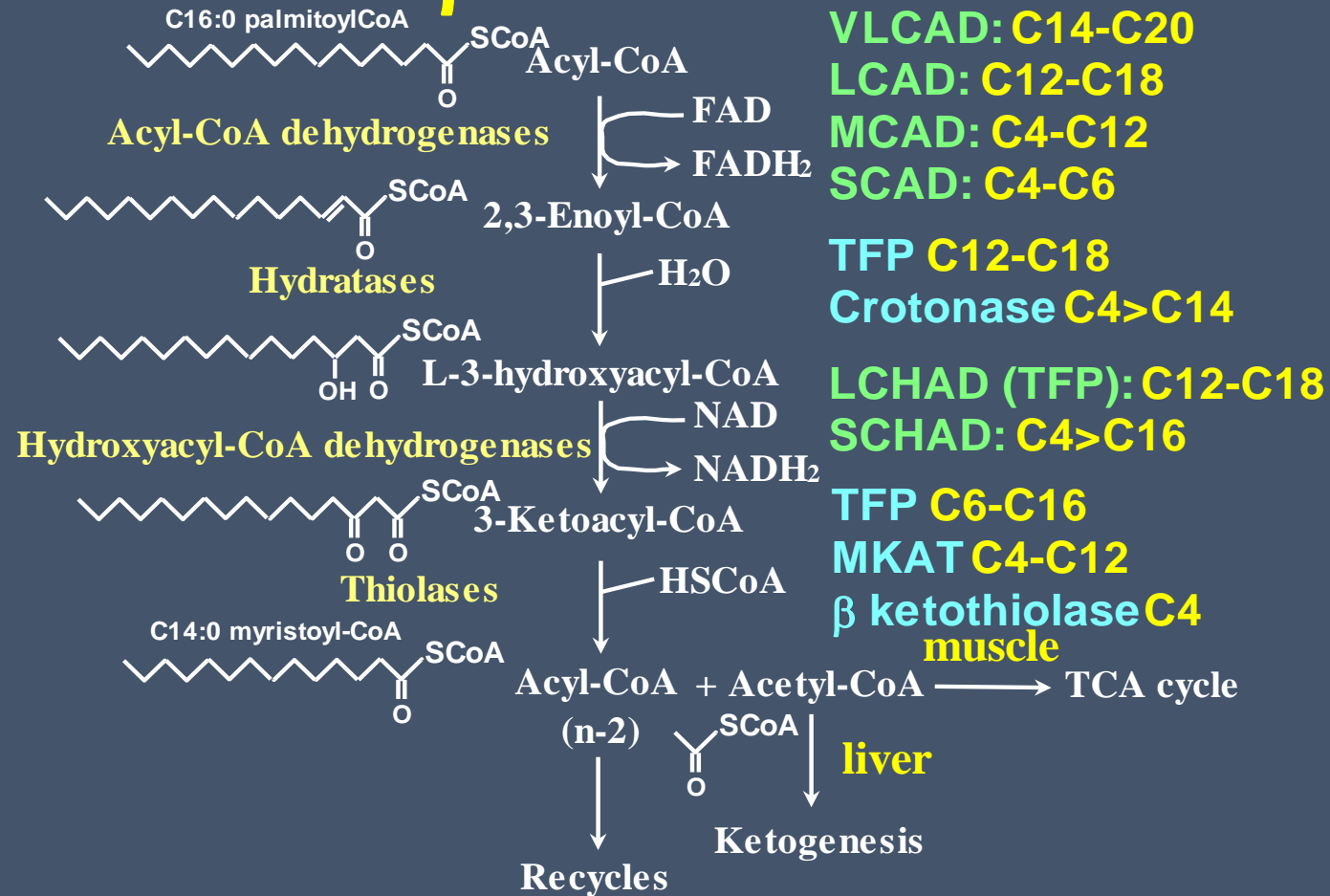

Pasquali M, Longo N. Newborn Screening and Inborn Errors of Metabolism. Chapter 70. In: Burtis CA, Ashwood ER, Brunz DE, eds. Tietz Textbook of Clinical Chemistry and Molecular Diagnostics. 6th ed. St. Louis: Saunders, 2017.

LCHAD Deficiency

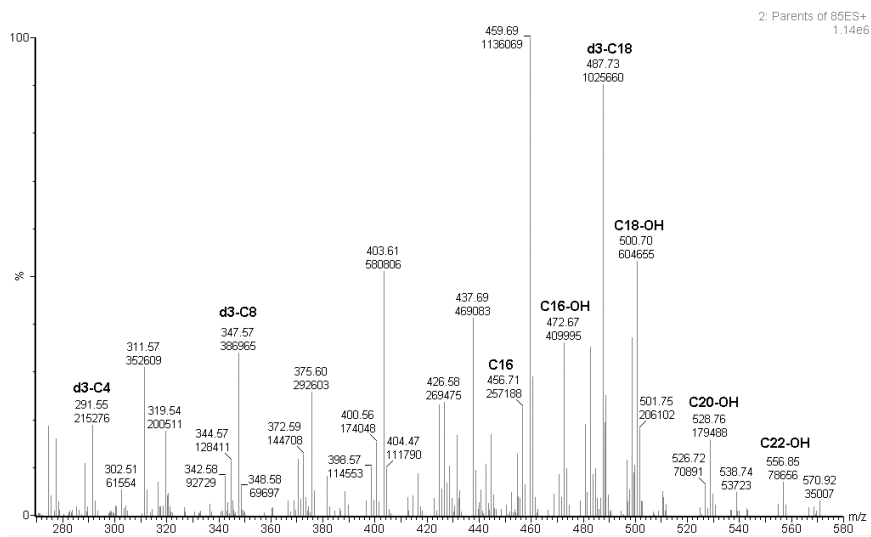
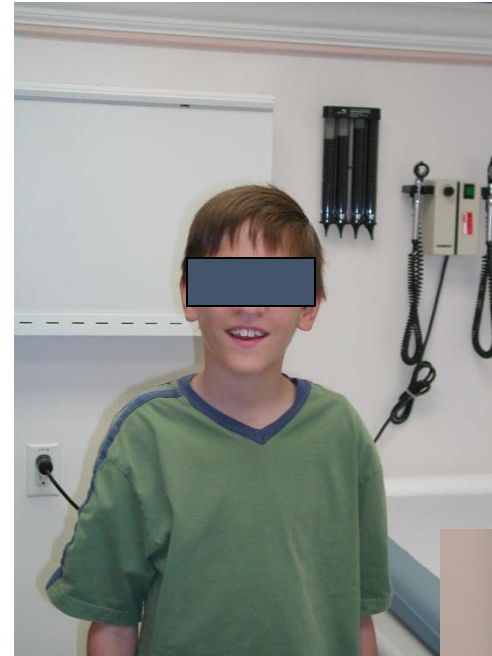
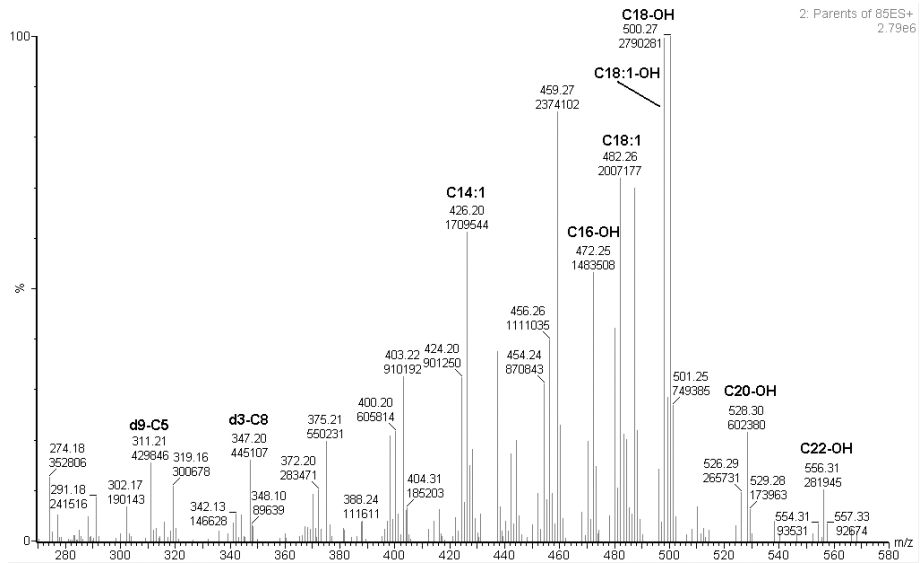

LCHAD Deficiency

- AFLP (acute fatty liver of pregnancy) syndrome or HELLP (hypertension, elevated liver functions, and low platelets) are frequent in mothers carrying a fetus with LCHAD deficiency
- Patients do very well when treated but can decompensate with fever, acquire infections, and require prompt hospital admission to receive IV glucose
- Mentality is normal



Summary

- Oxidation of fatty acids plays an important role in energy production during fasting
- Inherited defects of the carnitine cycle and fatty acid oxidation are relatively frequent and can present at any age when energy from fat is needed (fasting, infections, fever)
- Patients can appear perfectly normal between episodes
 - DNA testing is usually necessary to confirm or exclude the diagnosis



Summary

- LCFAODs include CACT, CPT2, VLCAD, and LCHAD/TFP deficiency
- Diagnosis: Plasma acylcarnitine profile can pinpoint the specific defect
 - Confirmation is by DNA testing
- Therapy in LCFAODs requires fasting avoidance, exercise limitation, and administration of medium-chain fatty acids or triheptanoin while restricting long-chain fats in the diet





***Tasia's Story:
Living with FAOD***

Diagnosis

- Normal pregnancy and delivery
- Noticed symptoms such as lethargy, breast milk intolerance, projectile vomiting
- Metabolic crisis at 4 months
 - Coma
 - ECHO showed heart enlargement (5X)
 - Originally diagnosed with LCHAD and then further testing confirmed VLCADD



Infancy

- Nose tube for 6 months
- Occupational therapy to transition to oral feeding
- Formula (MCT oil + Polycose)
- Caretaker: RN trained



Childhood



- Attended pre-school and then public school
 - 504 plan
- Symptoms limited
 - Experienced some low blood sugar
 - Muscle pain rarely
- Low-fat diet
- Active but took precautions
 - Carried snacks
 - Stayed hydrated
 - Strict medication regimen
 - Monitored physical activity closely

Adolescence

- Puberty (age 11) triggered symptoms
 - Muscle pain and rhabdomyolysis
- Constant fatigue
- Physical activity became limited
- Frequent hospitalization
- Depression and social isolation
- Started C7 (triheptanoin) trial at age 15
- By late adolescence, quality of life much improved

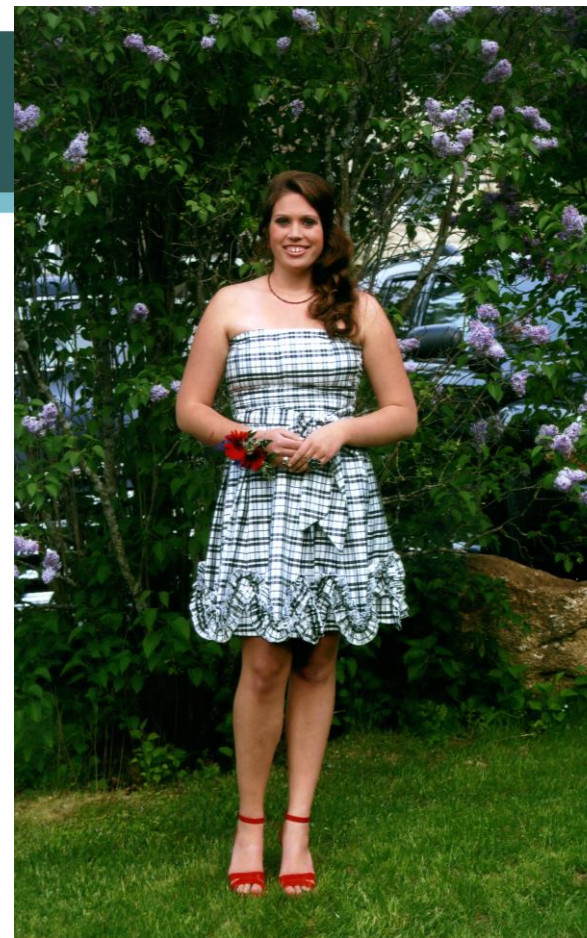

Young Adulthood

- 4 years of college at Boston University
- Learning to better manage the disease on my own
- Hospitalized 2-3 times per year in first 2 years, down to once per year or less by end of college
- Switched care teams from children's hospital to adult hospital to make hospital admission and care coordination easier

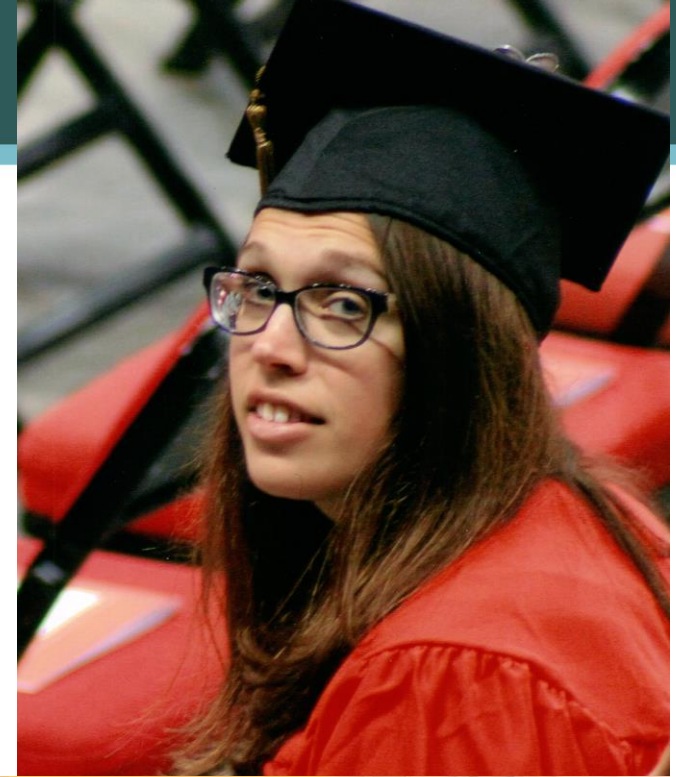

Living with FAOD: Common Triggers

- Viral illness, infection, allergies, injury
- Overexertion
- Lack of sleep
- Extreme heat or cold
- Fasting or not enough calorie intake
- Missed doses of medication
- Stress
- Menstrual cycle



Living with FAOD: Keys to Successful Management

- Diligence about medication and diet
- Routine
- Listen to my body
- Hydration
- Reduce stress
- Stay active and build muscle during healthy times
- Manage secondary conditions that may be a trigger (e.g., blood pressure, migraines)
- Build a support system
- Community





Pharmacist's Role

Specialty Pharmacy: Learning Objectives

- **Describe** the role of specialty pharmacy in rare diseases
- **Identify** therapies coming to market as specialty products
- **Understand** disease state and product profiles
- **Impact** patient care through services



ARS #1

1. According to the Orphan Drug Act (amended in 1984), no more than how many patients can be affected in the United States for a disease to be considered “Rare”?

- A. 7,000
- B. 50,000
- C. 100,000
- D. 200,000
- E. 500,000



What is a Rare Disease?

- Estimated 7,000 rare diseases
 - Only 5% have treatments
- U.S.: Orphan Drug Act (1983, amended 1984)
 - Disease that affects less than 200,000 people in the U.S.
 - 7 years of market exclusivity
 - Tax credits for costs incurred in evaluation
- EU NICE: Ultra Rare - 1:50,000
 - Approximately 6,500 patients in the U.S.
- Manufacturer focus
- Role for Specialty Pharmacy



Specialty Pharmacy and FAOD

- New products to market likely to be specialty
- Multiple disorders under FAOD
- Product profiles
- Patient needs



Where Do We Start?

- 
- Understanding of the disease state(s)
 - Causes
 - Impact on lives
 - Current treatments
 - Understanding the therapies
 - Product profiles
 - Needs for safe and effective dispensing
 - Understanding the patient
 - Their journey to get here
 - Patient education and assistance
 - Program design

Therapy Considerations

- 
- Route of administration and dosage form
 - Oral
 - Solution
 - Special handling requirements
 - Educational opportunities
 - How to use therapy properly
 - Storage and handling
 - Potential adverse effects and mitigation strategies
 - Adherence and persistence

Understanding the Patient

- Each has their own story
 - How did they get here?
 - What was their journey?
- They have unique needs and desires
 - How do they want to communicate?
 - Do they have any caregivers?
 - How can we make their life easier?



Specialty Pharmacy

- Reimbursement services
 - BI/BV
 - Co-pay support program knowledge
 - Patient assistance programs
 - Understanding of foundations for specific diseases
 - PA understanding/support
- Care management
 - Onboarding
 - Initial fill
 - Refill services
 - Off-cycle contact
- Data and reporting
 - Insights
 - Regular reporting

Dietary Assistance

Ozeri Touch III 22 lbs (10 kg) Digital Kitchen Scale with Calorie Counter



Metabolic^{ro}

GMDI
GENETIC METABOLIC DIETITIANS INTERNATIONAL



Questions & Answers



Thank you!